

Pressure Reducing Valve Type 582



General

- **Size:** 3/8"–2"
- **Material:** PVC, CPVC, PROGEF® Standard PP, SYGEF® Standard PVDF
- **Bonnet:** Glass-filled PP
- **Diaphragm:** PTFE/EPDM
- **Seals:** EPDM, FPM, PTFE
- **End Connection:** Solvent cement socket, threaded, flanged, fusion spigot, fusion socket
- **Mounting:** Stainless steel threaded inserts
- **Set Pressure Range:** 7-130psi
- **Hysteresis:** Approx. 1.5–5.8 psi
- **Standard Pack Quantity:** 1 valve

Key Certifications

- **FDA CFR 21 177.1520:** PP and PVDF
- **FDA CFR 21 177.2600:** EPDM and FPM
- **FDA CFR 21 177.1550:** PTFE
- **USP 25 Class VI (physiological non-toxic):** PP and PVDF
- **ABS:** All materials

Sample Specification

The Type 582 Pressure Reducing Valve shall control downstream pressure. The set pressure shall be controlled via an adjustment screw. The body shall be fully molded. The spindle shall be of non-rising design. The bonnet connection shall be of threaded design. Versions utilizing elastomeric cartridge seals shall be positive shutoff. Versions utilizing PTFE cartridge seals be leakage class C according to DIN EN1226-1. The seal material shall be indicated by the color of an external tab. ANSI versions shall meet ANSI B16.5 150lb standards. All valves shall be tested in accordance to ISO9393. All valves shall be manufactured under ISO9001 for Quality and ISO14001 for Environmental Management. Following assembly, every valve shall be tested and certified bubble tight exceeding Class VI standards.

Important Note

- Minimum of 15psi differential pressure required to ensure proper functionality.

Material Specification

PVC valves shall meet ASTM D1784 cell classification 12454 standards. CPVC valves shall meet ASTM D1784 cell classification 23447-B standards. PP valves shall meet ASTM D5847-14 cell classification PP0510B66851 standards. PVDF valves shall be type 1, grade 2 according to ASTM D3222 standards. Valves of all materials shall be RoHS compliant.

Valve Function

The pressure reducing valve reduces the line pressure to a set value on the valve outlet. The outlet pressure is in no direct relation to the inlet pressure. Independent of raising or falling inlet pressure, the outlet pressure stays constant.

Key Design Feature

Fully Molded

The Type 582 Valve Body is fully molded, providing several performance benefits. Machining bodies can create sharp corners at high stress points that can lead to stress cracking. The flow characteristics between two like machined bodies can differ significantly because of small dimensional inconsistencies and true union connections often require additional fusions which increases the number of leak paths in a given valve. The Type 582 eliminates all of these issues to provide consistent performance with a variety of end connection options.



Optional Features

- **Gauge:** SS304, Brass
- **Gauge Guard:** PVDF/EPDM, PVDF/FPM
- **End Connection:** Alternatives available upon request
- **Set Pressure Range:** 4-44psi
- **Cleaned:** Silicone free/oil free
- **High Purity:** Elastomeric version with positive shutoff

Material Availability

- $\frac{3}{8}$ " (d16) - PVC metric spigot (adapter unions available)
- $\frac{1}{2}$ "-2" (d20-d63) - All material/end connections



Optional Feature

Pressure Gauges

- A pressure gauge can be mounted on either side of the valve to accommodate required installation direction and ensure gauge visibility. The two sides of the valve are differentiated by a letter molded into each side of the valve as shown below, side A flow going left to right and side B flow going right to left.
- Standard gauges are 304 stainless steel or brass with either EPDM or FPM elastomeric seals.
- Alternative gauges of the user's preference can be installed upon request either with a threaded adapter or direct mount.
- All valve bodies can accommodate two gauges at a time and both sides can be drilled to measuring either upstream or downstream pressure.

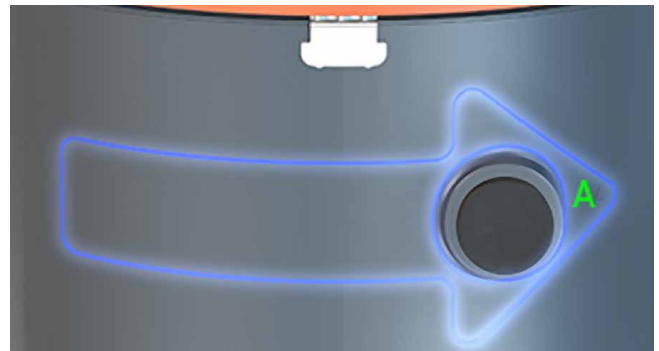

Components

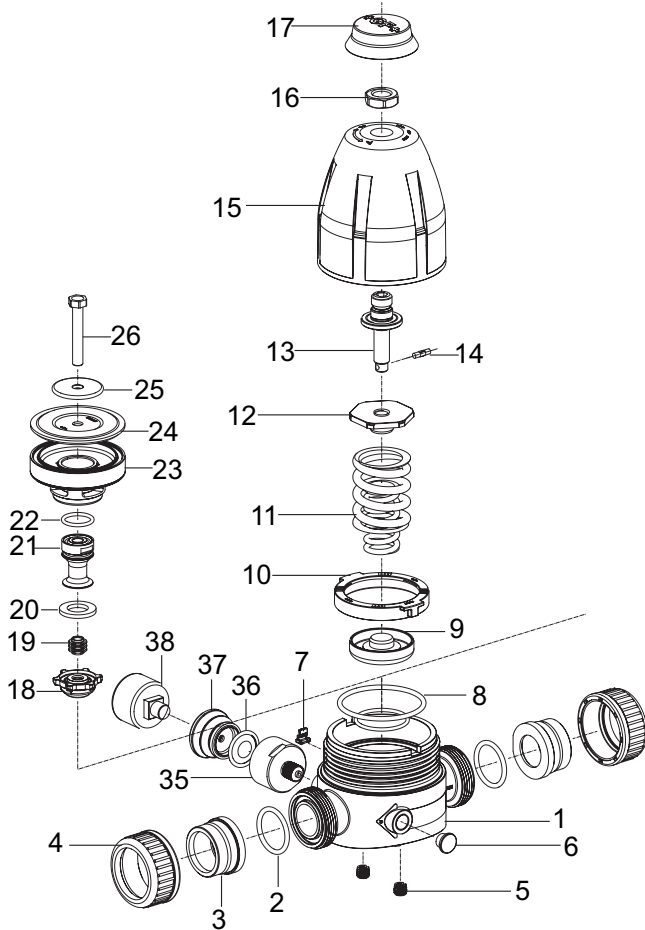

Part	Description	Material
1	Valve body	PVC, CPVC, PP or PVDF
2	Face seal	EPDM or FPM
3	Union end	PVC, CPVC, PP, PPn, ABS, PE or PVDF
4	Union nut	PVC, CPVC, PP or PVDF
5	Threaded insert	304 stainless steel
6	Gauge port plug	Glass-filled PP
7	Indicator tab	Glass-filled PP
8	Cartridge seal set	EPDM or FPM
9	Pressure piece	304 stainless steel
10	Retaining ring	Glass-filled PP
11	Spring set	Steel EN10270-1SH (C) Deltatone coated
12	Spring retainer	Brass
13	Spindle	304 stainless steel
14	Spindle pin	304 stainless steel
15	Bonnet	Glass-filled PP
16	Adjustment screw nut	304 stainless steel
17	Protective cap	Glass-filled PP
18	Cartridge nut cover	PVC, CPVC, PP or PVDF
19	Cartridge nut	304 stainless steel
20	Cartridge flat gasket	EPDM, FPM or PTFE
21	Piston	PVC, CPVC, PP or PVDF
22	Piston seal	EPDM, FPM or PTFE
23	Cartridge	PVC, CPVC, PP or PVDF
24	Diaphragm	PTFE/EPDM
25	Diaphragm plate	304 stainless steel

Key Design Features



Cartridge

The 5-Series PRV's modular design allows the user essentially completely rebuild a valve by swapping out the cartridge. A valve can be switched from reducing to retaining or vice versa in the same manner.

Modular Design

Multiple size valves of the same body material share components: $\frac{3}{8}$ " & $\frac{1}{2}$ ", $\frac{3}{4}$ " & 1" and 1 $\frac{1}{4}$ "-2" have all like components listed above numbers 6-25.

Technical Data

Pressure Temperature Curves

The following graphs are based on a 25 year lifetime water or similar media application

PVC

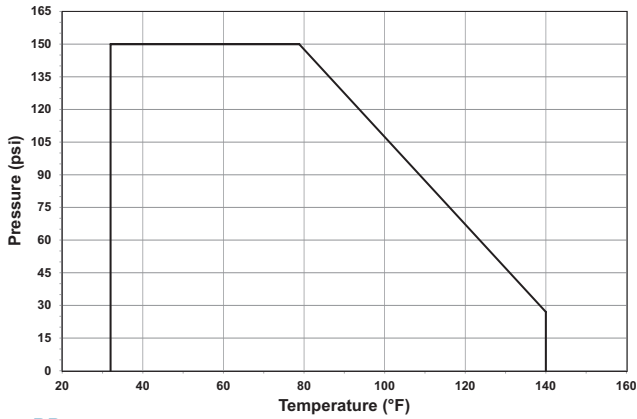

CPVC

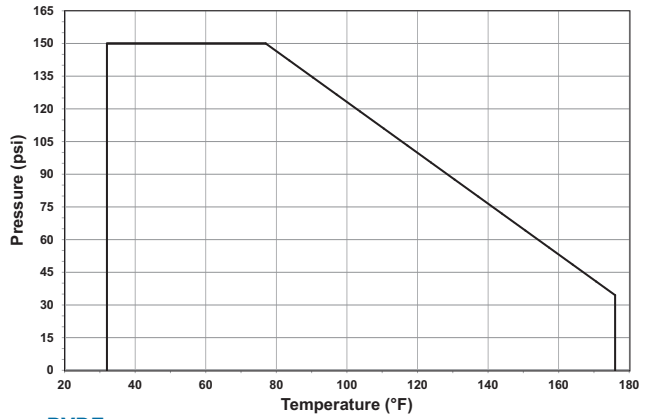

PP

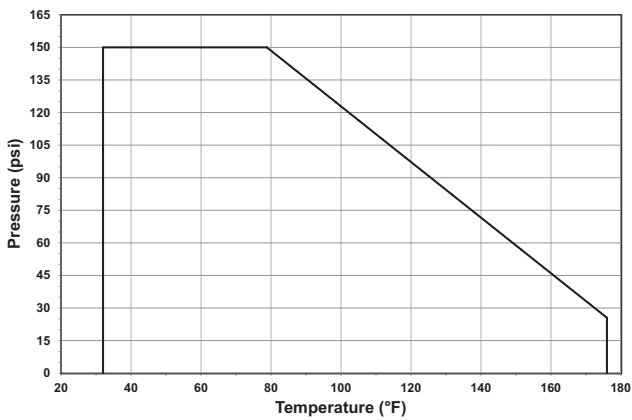

PVDF

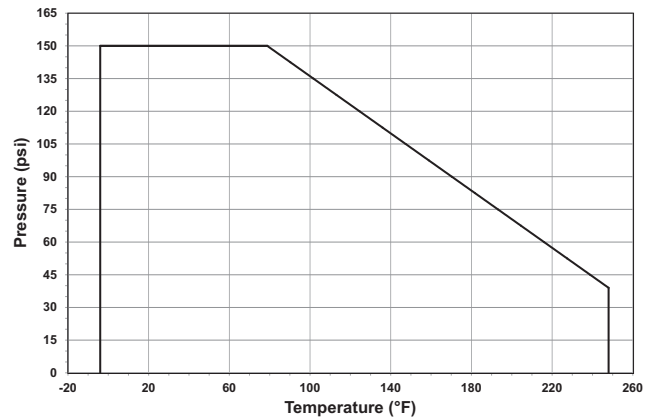

Pressure-Temperature

Material	Temperature Range (°F)	Max Pressure (psi)
PVC	32 to 140	150
CPVC	32 to 176	150
PP	32 to 176	150
PVDF	-4 to 284	150

Key Design Feature

The threaded bonnet design of the Type 582 was pioneered by GF and provides end users several benefits. Traditionally designed thermoplastic pressure regulating valves require metallic body bolts to compress the body seals. When a valve is used in a hot or cold line applications, the thermoplastic valve components and the metallic bolts expand and contract at different rates as they are heated or cooled. This can result in the degradation of the body seals that can only be avoided by the operator retorquing the body bolts following a significant process temperature change such as a hot line shut down. The threaded bonnet design eliminates this issue because the body and bonnet expand and contract at approximately the same rate, maintaining the diaphragm seal and reducing required maintenance.



Flow

The following graphs are based on a 25 year lifetime water or similar media application

Cv Values

Size (Inch)	d (mm)	Cv (gal/min)
3/8	16	3.1
1/2	20	3.3
3/4	25	7.7
1	32	8.9
1 1/4	40	17.5
1 1/2	50	20.2
2	63	22.0



Valve Sizing

Hysteresis Curve

The curves below are valid for the set range 7–130 psi and show the secondary or outlet pressure P2 over the flow Q in gal/min. Parameter is the set pressure pE at Q = 0 gal/min. These curves are valid for water at 70°F for a flow velocity of 6.6 ft/s.

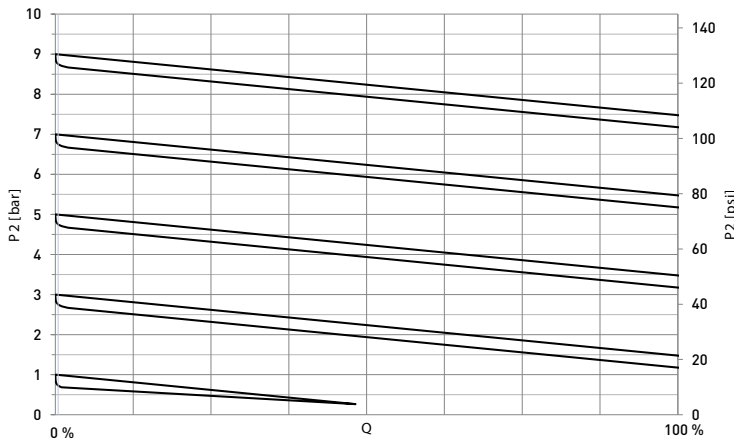

100% corresponds to a flow velocity of 6.6 ft/s

Max Flow Rates

Size	l/h	gpm
d16 (3/8")	1,000	4.4
d20 (1/2")	1,600	7.0
d25 (3/4")	2,500	11.0
d32 (1")	4,000	17.6
d40 (1 1/4")	6,000	26.4
d50 (1 1/2")	10,000	44.0
d63 (2")	16,000	70.4

On the left, you see the schematic diagrams of the hysteresis curve. The table above shows the maximum values at 100% in the diagram.

Key Design Feature

The high purity version of the Type 582 Pressure Reducing Valve provides several design improvements over competitive high purity PRVs. The elastomer free cartridge and reduced piston stroke greatly reduces particle shedding and leachable potential. All high purity valves are cleaned, assembled, tested and double bagged in a class 10,000 clean room.



Dimensions

The following tables are shown in millimeters unless otherwise specified

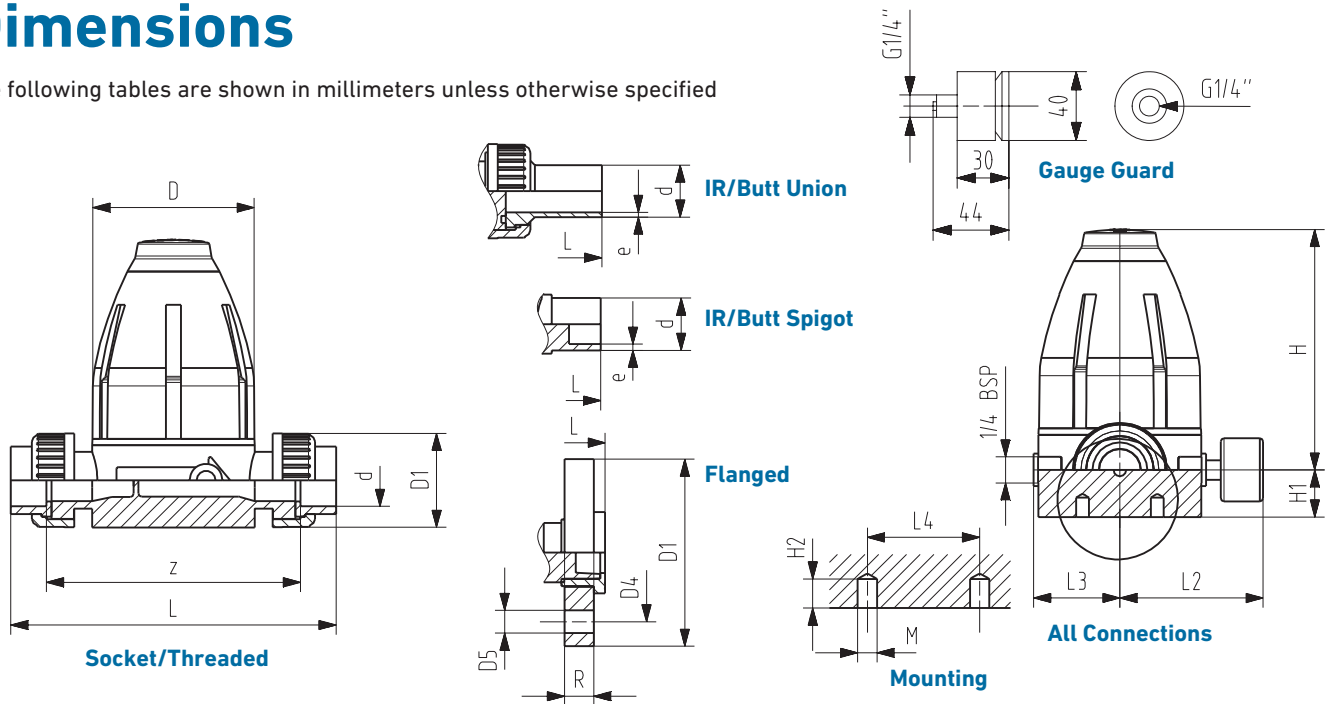

All Materials

Size (inch)	d (mm)	D	D1	H	H2	L2	L3	L4	M
3/8	16	79	43	111	12	77	42	45	M6
1/2	20	79	43	111	12	77	42	45	M6
3/4	25	100	51	148	12	88	53	45	M6
1	32	100	58	148	12	88	53	45	M6
1 1/4	40	147	72	207	15	111	76	70	M8
1 1/2	50	147	83	207	15	111	76	70	M8
2	63	147	101	207	15	111	76	70	M8

PVC/CPVC

Size (inch)	IPS Socket		Threaded NPT		ANSI Flanged				
	L	z	L	z	L	D1 (inch)	D4 (inch)	D5 (inch)	R (inch)
1/2	171	126	163	124	140	3.74	2.36	0.63	0.6
3/4	207	156	198	157	180	4.13	2.76	0.63	0.7
1	214	156	203	155	180	4.53	3.11	0.63	0.7
1 1/4	275	211	269	213	229	5.51	3.5	0.63	0.8
1 1/2	281	211	272	226	229	5.91	3.86	0.63	0.9
2	288	211	284	239	249	6.5	4.76	0.75	0.9

PP

d (mm)	IR/Butt Fusion Union		IR/Butt Fusion Spigot		Socket Fusion Union	
	L	e	L	e	L	z
20	228	1.9	150	1.9	158	126
25	264	2.3	190	2.3	192	156
32	270	2.9	190	2.9	196	156
40	331	3.7	240	3.7	255	211
50	337	4.6	240	4.6	261	211
63	343	5.8	259	5.8	269	211

PVDF

d (mm)	IR/Butt Fusion Union		IR/Butt Fusion Spigot		Socket Fusion Union	
	L	e	L	e	L	z
20	226	1.9	150	1.9	158	130
25	262	1.9	190	1.9	192	160
32	268	2.4	190	2.4	196	160
40	329	2.4	240	2.4	255	215
50	335	3	240	3	261	215
63	340	3	260	3	269	215